

# FC161 Hand-held Fundus Camera



Millisecond Focusing

# Auto Split Focusing Technology

## Millisecond Focusing Speed

FC161 adopts Auto Split Focusing technology, focusing speed reaches milliseconds. It avoids the out-of-focus of the fundus image caused by the patient's movement during shooting, effectively improve the image quality and reduce the requirements for cooperation between operators and patients.

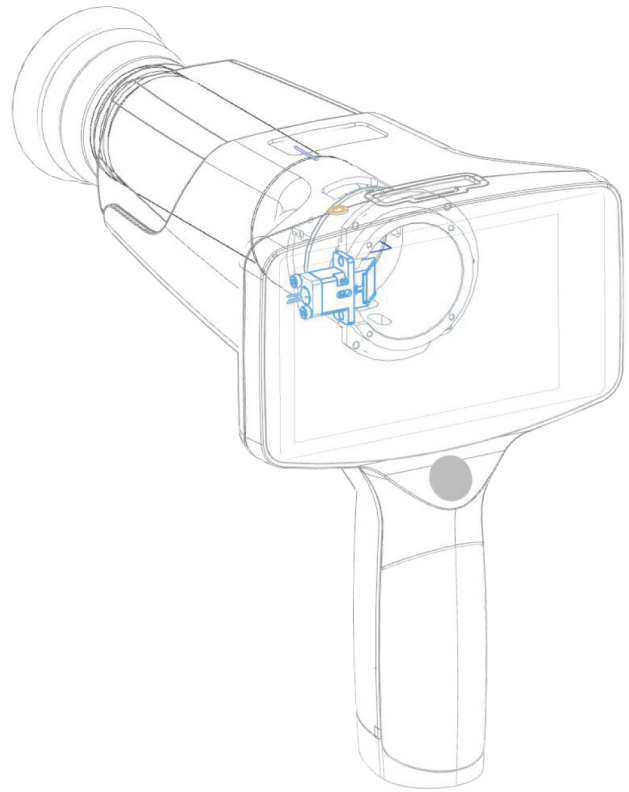
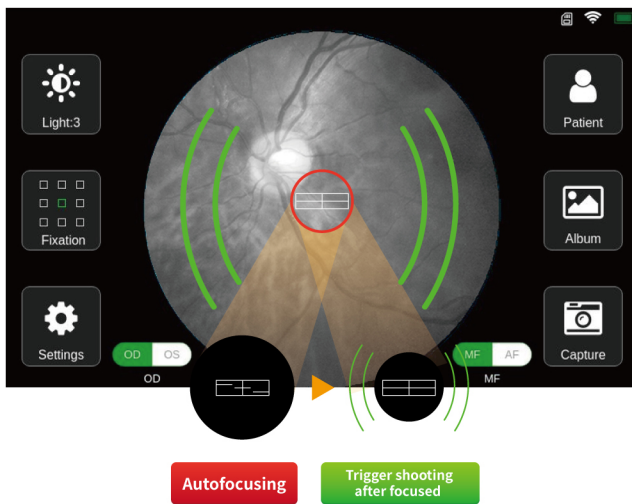

## Advantages

### High Resolution

FC161 provides high resolution fundus images, image resolution is up to 12 Mega Pixels. It makes the diagnosis of early lesions more accurate and also essential for diagnosing retina disease, such as diabetic retinopathy, glaucoma and macular degeneration.

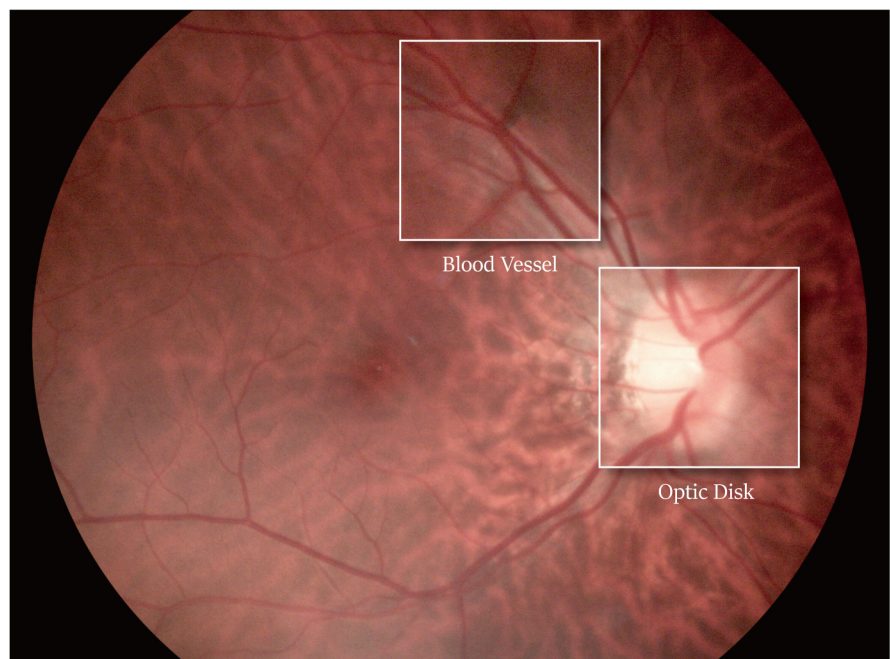

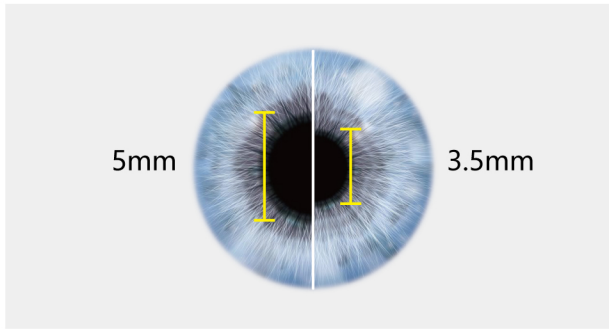

## Non-Mydriatic

The minimum pupil diameter of FC161 is  $\phi 3.5\text{mm}$ . 20 minutes of mydriatic waiting time is saved, and the risk of mydriasis to the patient is avoided.

## 9 Fixation Targets

With 9 fixation targets, FC161 covers 85° field of view of the fundus and supports the examination of early peripheral lesions of the fundus.

With 45° field of view, a single central fundus image can be taken to meet the needs of fundus disease screening.

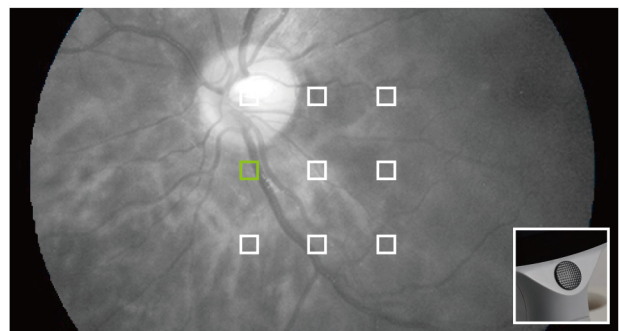

Easily select different fixation target by rotating direction key.

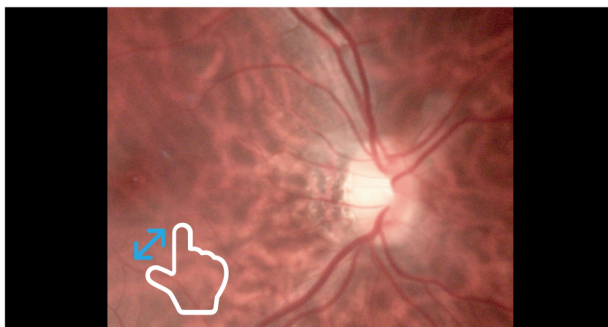

## Smart Touch Operation

4.3" full-touch LED screen brings a smarter operating experience. Doctors can zoom the image at any time to check the details of the fundus, and can also easily slide the screen to edit and view the case.

## Real-time Uploading

FC161 supports real-time synchronization between fundus images and Mediview Patient Management software through WIFI connection.

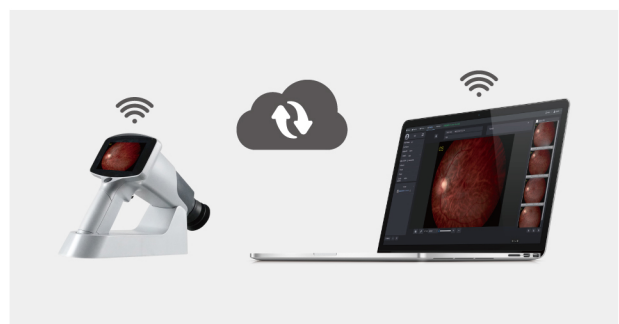

# Specification

	FC161
Type	Non-mydriatric
Filed of View	45degrees
Camera Sensor Resolution	12M Pixels
Fixation Targets	9×LED,Internal
Minimum Pupil Size	3.5mm
Illumination	White LED & IR LED
Focusing	Manual/Automatic
Focus Range	-20D ~ +20D
Display	4.3" Touch Screen
Image Format	JPEG
Type of Image	Color
Memory	Micro SD card. Maximum 32G
Data Connectivity	WIFI/USB
Power Supply	Rechargeable battery 3.7V/3400mAh x 2
Working Time	3 hours of continuous work
Charging Station	100-240V ~ , 0.5A, 50/60Hz
Power Supply	5V DC,2A
Dimensions	28cm×13cm×15cm
Weight	800g
languages	Chinese, English

## Standard Accessories

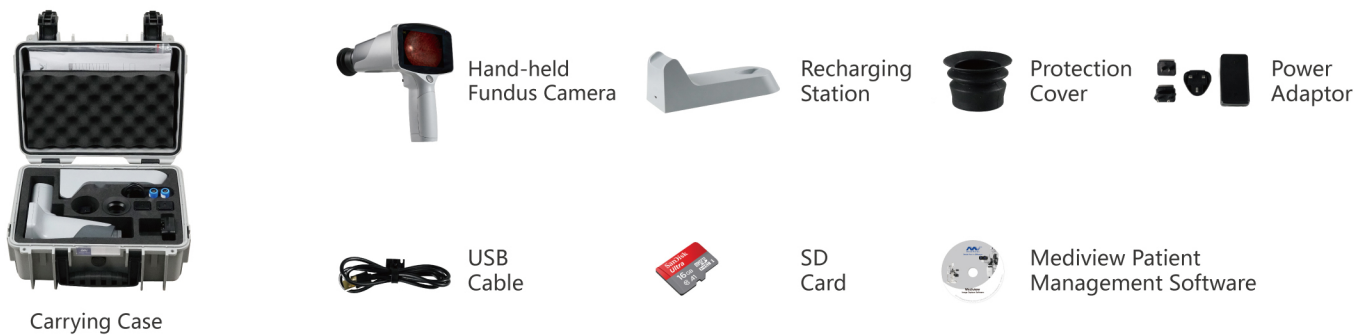

## Optional Accessories



Shanghai MediWorks Precision Instruments Co.,Ltd.

Add:Building 7, Ming Pu Plaza, No. 3279, San Lu Rd, Min Hang District,Shanghai, 201100,China

Tel: +86-21-54260421 54260423 Fax:+86-21-54260425

Email: Marketing@mediworks.biz  
International@mediworks.biz

Follow Us on



www.mediworks.biz